

Rivet tools / tools for blind rivets

RL20-2 Riveting tool

Operating manual



Content

1.	Operating instructions	5
2.	General description	5
3.	Scope of use	5
4.	Occupational health and safety	5
5.	Safety measures	5
6.	Special safety advice	6
7.	Basic tool equipment	7
8.	Commissioning	7
9.	Tool operation	8
10.	Proper Use	9
11.	Requirements for compressed air	10
12.	Riveting Tool Storage	10
13.	Transport Instructions	11

14.	Requirements for Operators	11
15.	Tool Modifications	11
16.	Inspection Plan	12
17.	Inspection and Maintenance	12
18.	Setup of the X-dimension	14
19.	Oil refilling	14
20.	Troubleshooting	15
21.	Technical parameters	15
22.	Disposal of the Riveting Tool	15
23.	Warranty	15
24.	Package Contents	16
25.	EC Declaration of conformity	17
26.	List of Safety Pictograms	18

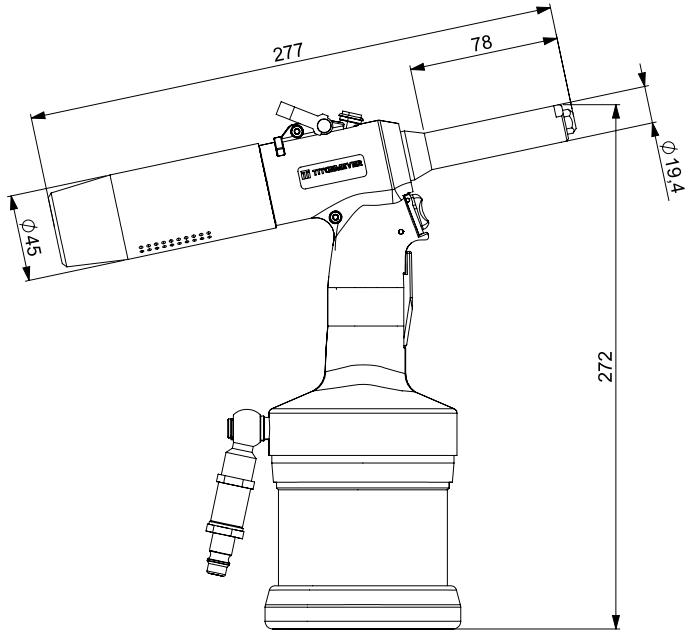
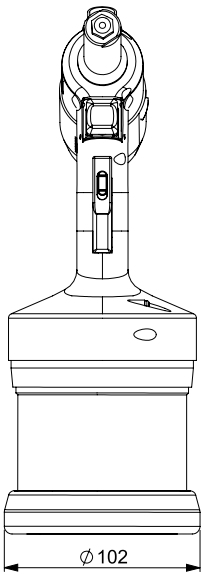

1. Operating instructions

Read the operating instructions carefully prior to use. Improper use may cause the tool to work incorrectly. All information and instructions apply to the specified tool and may only be used for the purpose of operating this tool.

All persons that adjust, operate or service the tool have to become familiarized with the operating instructions and have to follow them. In special cases training can be offered and organized by the seller.

The professional and safety measures must be followed in order to ensure that the tool works properly.

2. General Description

The RL20-2 riveting tool works with the high-speed hydro-pneumatic principle. The tool is designed for precise setting of blind rivets. It is equipped with a vacuum system for holding the rivet in the nosepiece in any position. After riveting the mandrel will be collected in the mandrel collector.

The high-speed pneumatic-hydraulic tool is designed for setting one-sided blind rivets from 2,4 to 5 mm. This tool with high stroke is also suitable for multi-grip blind rivets and blind rivets with soft materials.

The operating instructions must be read by every person using this tool. Pay attention to the safety regulations.

3. Scope of use

Size of rivets	2.4	3	4	4.8/5
Material Aluminium	X	x	X	X
Steel	X	X	X	X
Stainless	x	X	X	x

4. Occupational health and safety

The following instructions and directives apply to the riveting tool described in these operating instructions and to all user groups.

In addition to the general instructions in this Chapter that concerns the entire document and all procedures of using the riveting system, some parts of this document may contain additional safety instructions which then specifically relate to the described matter.

5. Safety measures

Basic safety measures to avoid damages and injuries.

Improper use of the tool may lead to an injury or damage of property.

To avoid damages, always adhere to the corresponding safety instructions of the safety measure. Only qualified staff are authorized to perform maintenance and repairs of the tool.

6. Special safety advice

The riveting tool is exclusively designed for setting one-sided blind rivets. The Customer bears individual responsibility for each and every change of the riveting tool!

ATTENTION!

- Use the tool only after reading and understanding the operating instructions.
- Do not operate with the tool if you are ill, under the influence of drugs, alcohol.
- Do not use the tool when it is incomplete and when it has visible mechanical defects.
- Never aim the riveting tool at people and do not rivet without material.
- Use the riveting tool only at working temperature ranging from 5°C to 45°C.
- Never get over the maximum limit of input air-pressure of 7 bar
- In case the provided air pressure exceeds the max of 7 bar, use appropriate equipment to reduce it.
- Use only fittings and hoses for an approved operating pressure of 10 bar in pneumatics.

- Before adjusting or replacing components, disconnect the tool from the compressed air supply
- For the used rivet diameter, use the suitable nosepiece (5) accordingly.
- Always use personal protective equipment.
- Tool not in current use must not be connected to the compressed air supply
- Use the tool only for riveting
- Do not use the tool without assembled nosecap (6).
- The riveting tool must not be carried or lifted by the air hose
- Make sure, the suction system is not activated, while disassembling the mandrel collector (2), for emptying.

ATTENTION!

Make sure that the mandrel collector is always attached on the riveting tool when in use, otherwise there is a risk of injury.

NOTE

The Manufacturer bears no liability for damages incurred due to incorrect repair or using spare parts from other sources. The warranty is deemed invalid in case of any repairs have been performed on the riveting tool, leading to the damage of the riveting tool or the seals.

7. Basic tool equipment

Overview of RL20-2
basic tool equipment:

1. Air connection
2. Mandrel collector
3. Balancer suspension attachment
4. Screw for oil refill
5. Nosepiece
6. Nosecap
7. Trigger
8. Air suction trigger

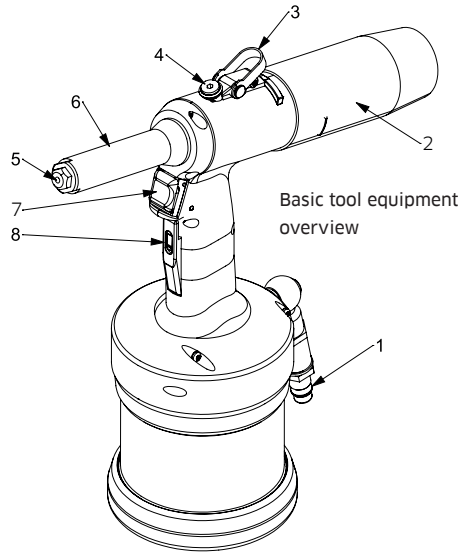

8. Commissioning

Check the riveting tool visually before commencing any work

- For visible damages
- For oil leaks

Select the correct nosepiece for the used rivet and check that the nosepiece and nose cap are tightened firmly
Test of the tool function without rivets
prior processing –20 times

9. Tool operation

- Check the tool operation after inspection or before first use (commissioning)
- Connect the tool to the air supply (6 - 7 bar)
- To avoid damage to the tool, caused by exceeded air pressure, the integrated safety valve will switch to release air. In this case, adjust the air pressure to the correct value.
- Check for correct assembly and fit of the quick connectors - no air discharge is audible
- Press and hold the air suction trigger (8) - the riveting tool starts soaking air through the nosepiece.
- Insert the mandrel of the rivet in the nosepiece (5) (the rivet will be held in nosepiece by the air flow).
- Move the tool with rivet to the allocated riveting position.
- Press the trigger (7) - the riveting tool performs the pulling movement (pulling and tearing the mandrel)
- Release the trigger (7) after setting the rivet and the pulling unit automatically returns to its initial starting position
- Hold the air suction trigger (8) during the riveting cycle to eject the ripped off mandrel into the mandrel collector (2).
- Make sure, the mandrel is ejected before the next riveting cycle.
- Release the air suction trigger (8), to switch off the air suction flow.

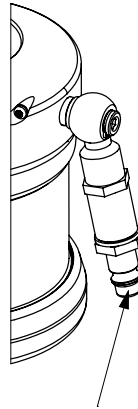

Connecting the tool with the air supply

10. Proper Use

To ensure that all the corresponding safety measures are observed and that the riveting tool will work properly, the following is required:

- The system has to be used in compliance with the tool's technical data and specifications concerning the use, assembly, connection, environment and work conditions. These conditions are stipulated in the documents related to the order, user information (tags etc.) and in the documentation delivered with the system, which includes the operating instructions, as well as the maintenance and inspection instructions in this manual.
- The users have to act in compliance with local and system-specific conditions and pay corresponding attention to the operating hazards and specifications.
- All measures required for the maintenance of the tool, e.g. transport and storage, as well as the requirements for maintenance and regular inspection must be observed.
- Use only a safety quick coupler for permanent connection to the compressed air sources
- The mandrel collector must always be emptied as soon as it exceeds half load capacity
- Always set the riveting tool at the right angle (90°) to the assembly surface

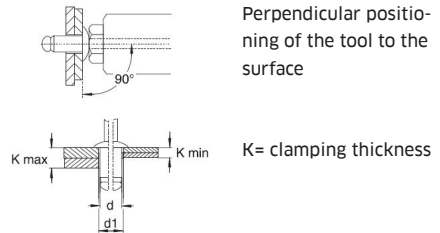



Compressed air supply

- For correct operation of the device, it is necessary to observe the range of inlet air pressure between the minimum and maximum permissible value of 6 - 7 bar. If necessary an appropriate pressure reduction valve has to be used. In case of non-compliance, personal injury or damage to the device may occur.
- The pressure regulator must be equipped with a filter unit for separating dirt and condensation from the air supply. In case the pressure regulator with a filter unit will not be used, it must be ensured that the compressed air cannot contain dirt and condensation.
- The length between the air supply pressure regulator and the tool must not exceed 3m.
- Supply line must be resistant to oil, liquids and operating conditions
- Air hoses must have a 6 mm minimum inner diameter.
- Maximum force depend on compliance of the inlet pressure

11. Requirements for compressed air

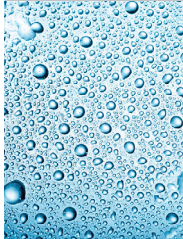
ISO 8573-1

Air quality classes under ISO 8573-1	Solid particles		Water	Oil
				
	Maximum size μm	Maximum concentration mg/m^3	Maximum pressure dew point $^{\circ}\text{C}$	Maximum concentration mg/m^3
2	1	1	-40	0.1

Note: The stated maximum concentrations relate to 1 bar abs., +20°C and 60% relative humidity. The individual concentrations are proportionally higher when the pressure is higher than atmospheric pressure.

12. Riveting Tool Storage

After first use

If you are not going to use the riveting tool any further, place it in the original packaging and store it in a dry and dust free environment.

After long-term storage

After long-term storage (about 3 years), replace the hydraulic oil before use. The hydraulic oil may only be replaced by a trained expert, according to the operating instructions. If required, you can contact the Titgemeyer service centre for a professional service.

13. Transport Instructions

The tool is delivered completely assembled. It has to be handled like a fragile equipment. This product contains hydraulic oil.

14. Requirements for Operators

All planning, assemblies, installations, activations, maintenance and repairs may only be performed by trained staff and inspected by technical experts. Training may be provided by the manufacturer by agreement.

The persons responsible for health and safety must ensure the following:

- All works related to safety are only performed by qualified staff.
- The staff must be qualified on the basis of their specialization (training, education, experience) or on the basis of their knowledge of corresponding standards, specifications, accident-prevention regulations and system properties. It is essential that such persons are capable of identifying and avoiding any potential risks in timely manner.

15. Tool Modifications

No structural modifications that could negatively affect the tooling safety may be performed on the tool without the manufacturer's consent. Any unprofessionally performed repairs and the use of incorrect spare parts are deemed to be interference in the design of the tool; the manufacturer cannot guarantee the correct function of the tool or provide warranty to the product in such cases. The warranty does not apply to the tool with damaged seals.

Risk of injury in case of incorrect manipulation!

Working with this tool may not be dangerous for the operator, when the regulations in this manual have been read, understood and followed. The operator must follow the operations described in this document. The maintenance and service work that is not described in these operating instructions may only be performed by trained experts who are trained by TTA.

16. Inspection Plan

Intervals of inspection plans

- Daily inspection
 - Check for oil leaks
 - Check for unexpected air exhaustion
 - Check if the tool works well and performing a correct setting process
 - Check correct setting and tightening of riveting mechanism
 - Check if the nosepiece (5) is worn - in case of visible wear replace the nosepiece
 - Check that the mandrel collector (2) is assembled correctly.
 - Stop using the tool immediately when you notice any sign of a fault.
- Weekly inspection/ after 5.000 cycles
 - Check the nosepiece (5) and jaws, clean or exchange the damaged and worn parts.
 - Refill the oil, if necessary
- Complete inspection made by authorized person (or by producer) once per year/ or after 500.000 cycles
 - Complete check and service of the tool mechanism
 - Inspection and change any worn parts
 - Perform oil change

Do not use any highly active cleaning agents or flammable liquids when cleaning!

The riveting tool must be cleaned and checked in case of any mechanical defects as for the corresponding type of application. After the riveting tool has been cleaned to be stored for a longer period of time, all external metal parts need to be lightly greased with corrosion inhibitor.

17. Inspection and Maintenance

Jaws Cleaning or Replacement

- Jaws need to be cleaned once a day or after 2.000 rivets have been set (depends on the rivet material and quality). In case of larger rivet processing amounts, cleaning is performed as needed. Jaws are subject to mechanical wear and have to be replaced as soon as they start slipping when the rivet mandrel is held.
- Disconnect the tool from the compressed air supply
 - Loosen the front nosecap by wrench no. 16, unscrew and carefully remove it
 - Release the galvanized lock by pulling towards the tool and unscrew the jaw case
 - Remove the jaws from the jaw case. Clean the head and the jaws, remove any chips in the spring and the spring guide or replace the parts when worn or damaged

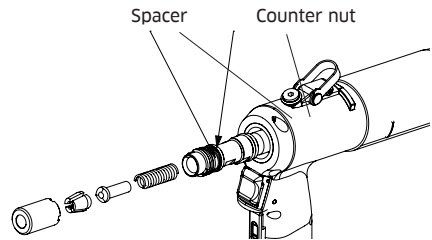
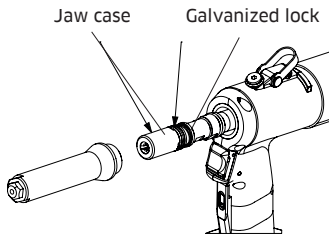

- Lightly grease the new jaws on the outer circumference and insert them (teeth to the axis) in the jaw case. Screw the head back on the adapter. The lock automatically secures the jaw case against release. Tighten only to the last possible tooth of the lock. **Do not use a wrench for tightening!**
- It could damage the lock.
- Carefully screw on the front nosecap and tighten it with wrench no. 16.
- Check the x-dimension value (chapter 18. Setup of the X-dimension)

Nosepiece Disassembly and Assembly

Disconnect the tool from the compressed air

Use a wrench no. 16 to hold the tool's nosecap by the flats at the front and loosen the nosepiece using wrench no. 11. Then loosen the entire nose-cap using wrench no. 16. Remove the nosecap and manually unscrew the nosepiece.

Take the selected nosepiece and manually screw it onto the removed nosecap. Mount the nosecap back onto the tool and tighten with wrench no. 16 (flats) and no. 11 (nosepiece)

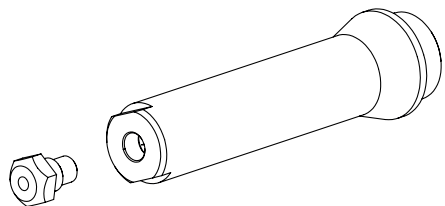

18. Setup of the X-dimension

When the grips open, the distance of the clamping head, or the x-dimension, must be set correctly. The setting is performed by the Manufacturer. The basic x-dimension (the distance from the jaw case to the tool body) is set at 80 mm.

If it is necessary adjust the x-dimension by counter nut and spacer by using wrenches no. 15 and 12. Maximum allowed X-dimension is 80 mm with default nosepiece and pulling head. Minimum X-dimension is limited by the thread on the piston. With higher size of X-dimension it is possible to reach wider jaw opening in case the rivet mandrel gets stuck in the jaws. On the other hand with lower X-dimension the jaws may grip the mandrel faster. This is advantageous in situation where the mandrel is short and the jaws grip it in the back. It is always necessary to check if the pulling head does not collide with the nosepiece to prevent any damage

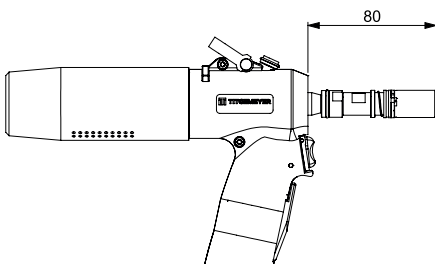

19. Oil refilling

- Oil needs to be refilled when the working stroke is reduced during working process
- During oil refilling, prevent dirt from entering the hydraulic system
- Disconnect the tool from the compressed air
- Remove the nosecap (see chapter jaws cleaning and replacement)
- Use allen key no. 3 to unscrew the screw in the top of the tool
- Fill up the syringe with the recommended hydraulic oil (chapter 19. Technical parameters), attach it to the brass adapter and screw the adapter on the outlet
- Press the hydraulic oil into the tool and pump the syringe piston several times. As you are pumping, you can see that the hydraulic piston is moving forward and backwards.
- Unscrew the adapter, mount the screw and USIT ring, mount the nosecap (see chapter jaws cleaning and replacement)
- Clean the tool from any spilled oil
- Activation of the tool without rivets - 20 times (Tool operation)

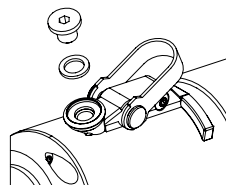

20. Troubleshooting

The operator must ensure the following:

- The maintenance staff can be notified immediately and at any time.
- The maintenance staff is qualified to properly respond to the failure of the riveting tool and the failure of related systems.
- The failures are analysed by qualified staff, any defects are repaired and the operation is optimised in a way that prevents any similar failures in the future.

21. Technical parameters

Total weight (according to the version)	1,4 kg
Dimensions (HxL)	269 x 277 mm
Blind rivet diameters	2,4 - 5 mm, max. Ø of mandrel 4mm
Tractive force	11,9 kN / 6 bars
Stroke	17,5 mm
Speed of rivet cycle	0,9 s
Air consumption for 1 rivet	2,7 l [ANR]
Air consumption - exhaustion	465.5 l/min [ANR] (78 l/min @6 bar)
Noise level	86,5 dB
Operating pressure	6 bar, max. pressure 7 bar
Compressed air connection	6 mm, (G 1/4")
Hydraulic oil standard	Mineral hydraulic oil of class VG 32 according to ISO TC 28/SC4 with a viscosity of 32 mm ² /s at 40 degrees. C
Sample hydraulic oil product	OH-HM 32
Lubricant standard	Plastic grease ISO 6743-9
Sample lubricant product	LV2EP

22. Disposal of the Riveting Tool

Disposal of the tool in compliance with the EU directives. Check for hydraulic oil inside the riveting tool. Remove it and dispose the oil in an environmentally friendly manner.

23. Warranty

Titgemeyer GmbH & Co. KG provides a 12- month warranty from the date of purchase. The warranty does not cover

consumables (jaws, nosepieces, mandrels, etc.)

Titgemeyer GmbH & Co. KG warrants that all power tools have been carefully manufactured and that they will be free from defect in material and workmanship under normal use and service for a period of one (1) year. This warranty applies to the first time purchaser of the tool for original use only.

Exclusions: Normal wear and tear. Periodic maintenance, repair and replacement parts due to normal wear and tear are excluded from coverage. Abuse & misuse. Defect or damage that results from improper operation, storage, misuse or abuse, accident or neglect, such as physical damage are excluded from coverage. Unauthorized service or modification. Defects or damages resulting from service, testing adjustment, installation, maintenance, alteration or modification in any way by anyone other than Titgemeyer GmbH & Co. KG, or its authorized service centres, are excluded from coverage.

Should this tool fail to meet the warranty, promptly return the tool to our Titgemeyer GmbH & Co. KG service center or factory authorized service centre location nearest you.

Titgemeyer GmbH & Co. KG will then replace, free of charge, any part or parts found by us to be defective due to faulty material or workmanship, and return the tool repaired. This represents our sole obligation under this warranty. In no event shall Titgemeyer GmbH & Co. KG be liable for any consequential or special damages arising out of the purchase or use of this tool.

24. Package Contents

- 1 x riveting tool
- 1 x Nosepiece Ø 2,4
- 1 x Nosepiece Ø 3
- 1 x Nosepiece Ø 4
- 1 x Nosepiece Ø 5
- 1 x Allen key no. 3
- 1 x open single-end spanner SW11
- 1 x syringe
- 1 x adapter
- 3 x USIT sealing ring 6mm

26. List of Safety Pictograms



Use protective goggles



Use protective gloves



Use ear protection



Tools & Automation

DECLARATION OF CONFORMITY

Product Name: Riveting tool RL20-2

Catalogue Number: 99-0301:TTA

Type number: 99030102012021

The RL20-2 riveting tool works with the high-speed hydro-pneumatic principle. The tool is designed for precise setting of blind rivets. It is equipped with a vacuum system for holding the rivet in the nosepiece in any position. After riveting the mandrel will be collected into the collection bottle.

Manufacturer:

Titgemeyer Tools & Automation spol. s r.o.

U Vodárny 1506

CZ 397 01 Písek

IČ 60647761

Tel: + 420 732 657 208

TTA-sales@titgemeyer.com

We hereby declare that the products conform to the following standards and guidelines:

2006/42/ES, the Machinery Directive

Name	Date and place	Signature
Approved by Director Antonín Solfronk	In Písek 31.03.2021	

Titgemeyer Tools & Automation spol s.r.o.

U Vodárny 1506

39701 Pisek

Tschechien

T + 420 382 206 711

E tta-sales@titgemeyer.com

W titgemeyer.com